

## Designing a 50W Forward Converter Transformer With Magnetics Designer

In order to introduce you to the power of Magnetics Designer, we will synthesize a transformer for a forward converter which is similar to that shown in Figure 1.

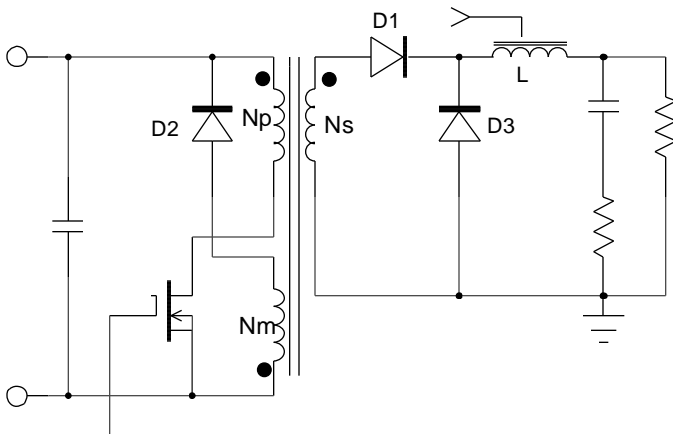

**Figure 1**, Magnetics Designer can synthesize transformers for designs like this forward converter.

When the transistor turns on, the voltages on the starts (dotted ends) of the transformer are driven positive, forward biasing D1. While the voltage is positive, the inductor current increases towards its maximum value while magnetizing current builds up in the transformer. When the transistor turns off, transformer magnetizing must continue to flow. Therefore, the only path for magnetizing current to flow is through D2, thus reversing the polarity across the transformer and providing a voltage to reset the flux. However, when the current in the transformer winding reaches zero, the voltage across the winding reduces to zero, indicating that the transformer flux has returned to the residual flux of the core material.

Throughout the off-time of the transistor, inductor current decays. However, if the inductance is large enough, the inductor current will not return to zero and the converter is described as operating in the continuous conduction mode. If the inductance is small, the inductor current returns to zero during the off time. The second case is described as operating in the discontinuous mode. In this example, we will assume that the converter is operating in the continuous mode. The forward converter waveforms are shown in Figure 2.

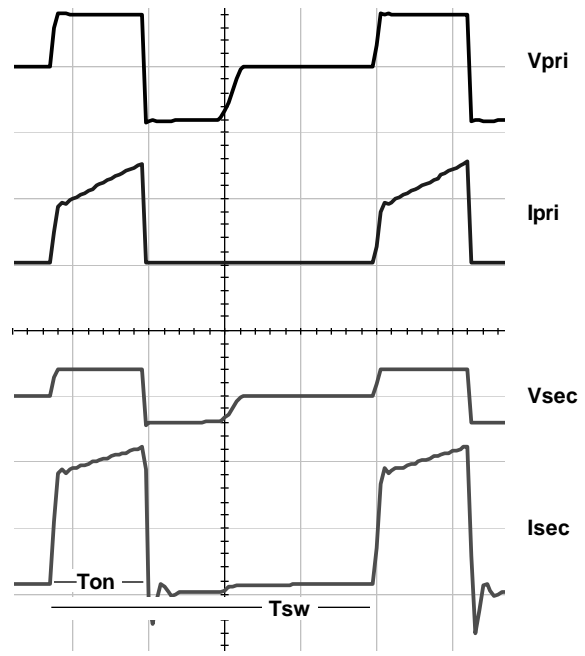

**Figure 2**, Key waveforms for the forward converter.

The following equations describe the converter behavior:

**Output voltage:**  $V_o = Dk_t\eta V_{in}$

where  $V_o$  is the output voltage,  $D$  is the duty cycle of the switch,  $\eta$  is the efficiency of the converter,  $V_{in}$  is the input voltage, and  $K_t$  is the turns ratio transformer.

**P-P Inductor Current:**  $\Delta I_L = \frac{(1-D)T_{sw}}{L} (V_o + V_{fwd})$

where  $I_L$  is the peak-to-peak inductor current,  $V_{fwd}$  is the rectifier forward voltage,  $T_{sw}$  is the switching time and  $L$  is the inductance.

**Ave. Inductor Current:**  $I_{L(ave)} = I_o = \frac{V_o}{R_o}$

where  $I_o$  is the output current, and  $R_o$  is the load resistance.

Generally, a converter must operate over a wide dynamic range of input voltage and load current. However, Magnetics Designer only needs to consider the case which results in the maximum transformer ratings. For the forward converter, this is low line where the RMS current in the windings is maximum and duty cycle is .5 (50%). Since the average output voltage from the regulator is maintained at a constant, the core losses, on a first order basis, are unaffected by line and load changes.

The maximum required steady state output for our design is +5Vdc at 10Adc with a minimum input voltage of 40V. The transformer output voltage must, on the average, be equal to the output voltage plus the rectifier drop. Assuming that the 5 volt output uses conventional rectifiers, the transformer output voltages should be somewhat greater than 5.7V. Using the previous equations, with a frequency of 100kHz, and an 8µH inductor, the peak-to-peak inductor current is 3.56A. I<sub>pk</sub> (I<sub>p</sub>) is therefore 11.78A (I<sub>p</sub>=I<sub>dc</sub> + I<sub>p-p</sub>/2, I<sub>m</sub>=I<sub>dc</sub> - I<sub>p-p</sub>/2). The average voltage across the secondary is (V<sub>o</sub>+V<sub>fwd</sub>)/D = 5V+.7V/.5 = 11.4V.

For a unipolar trapezoidal waveform, the DC current is:

$$I_{dc} = \frac{D(I_p + I_m)}{2} = .5(11.78 + 8.22)/2 = 5A$$

The RMS current in the winding is given by:

$$I_{rms} = \sqrt{D \left( I_p \times I_m + \frac{1}{3} (I_p - I_m)^2 \right)} = 7.11A$$

Knowing the DC and RMS currents, the AC current is:

$$I_{ac} = \sqrt{I_{rms}^2 - I_{dc}^2} = 5.05A$$

The required turns ratio is then V<sub>pk-pri</sub>/V<sub>pk-sec</sub> = 3.508. (The average voltage on the primary, which is the same as the peak voltage for a square wave, is 40 V while V<sub>pk-sec</sub> is 11.4 V). The DC (I<sub>dc-pri</sub>) current on the primary is 1.43 Adc (=5/3.508) and the AC component of current is 1.44 Arms (=5.05/3.508).

A forward converter has a flux swing which begins at B<sub>r</sub> and achieves a maximum value, B<sub>max</sub>. Therefore, the flux type is half wave. The output power is 57 watts (5.7 Vdc x 10 Adc). We also assume that the converter operates at 100 kHz, that the ambient air temperature is 25 degrees C, and that the maximum desired surface temperature is 75 degrees C (50 degree rise).

Finally, it is assumed that the inductor ripple current and transformer magnetizing current are small relative to the various winding currents and that they do not appreciably affect the RMS current in any of the transformer windings. Without this assumption, the waveforms for each winding would be more complicated, and additional effort would be required in order to calculate the transformer requirements.

The transformer's design assumptions are summarized below:

Core Type	= Pot Core, Ferrite, Magnetics
Material type	= F (High Frequency, 100 deg. C data)
Max Temp. Rise	= 50 deg C
Max. Amb. Temp.	= 25 deg C
Max. Window Fill	= 90%
Flux Type	= Half Wave
Output power	= 57 Watts
Frequency	= 100 kHz
Waveform Type	= Square Wave
V <sub>pri</sub>	= 40 V ave
I <sub>dc-pri</sub>	= 1.43 Adc
I <sub>ac-pri</sub>	= 1.44 Aac (rms)
V <sub>sec(5v)</sub>	= 11.4 V average
I <sub>dc(5v)</sub>	= 5 Adc
I <sub>ac(5v)</sub>	= 5.06 Aac (rms)
V <sub>flyback</sub>	= 40.0 V average
I <sub>ac(40v)</sub>	= 200m Aac (rms)

### Initial Computer Generated Design

The core material and family are first selected in the Core Selection screen (Figure 3). After entering the power and frequency, the Core Browser is used to make an initial core selection. The Core Browser will select the smallest core that can handle the frequency and power specified.

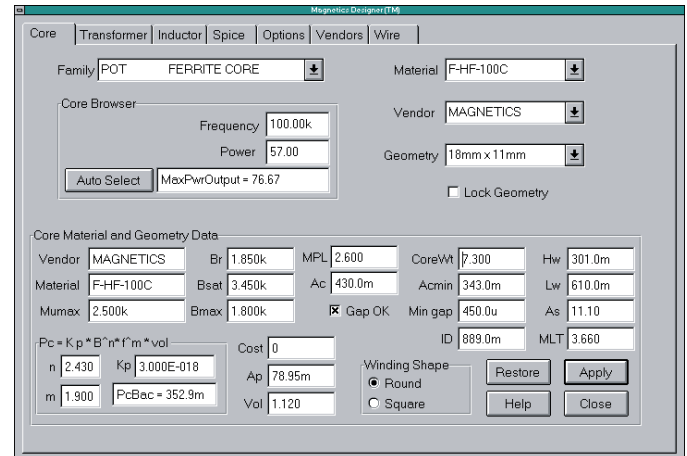

**Figure 3**, The Core selection screen, after using the Core Browser to make an initial core selection.

The electrical requirements for the three windings are then entered on the Transformer design screen (Figure 4). The pencil icons indicate fields where data can be entered. The eye glasses indicate calculated "per winding" results that can be viewed. The User Data section on the right contains input and output parameters associated with the entire design. Design constraints (temperature rise, window fill, etc.) are entered at the top.

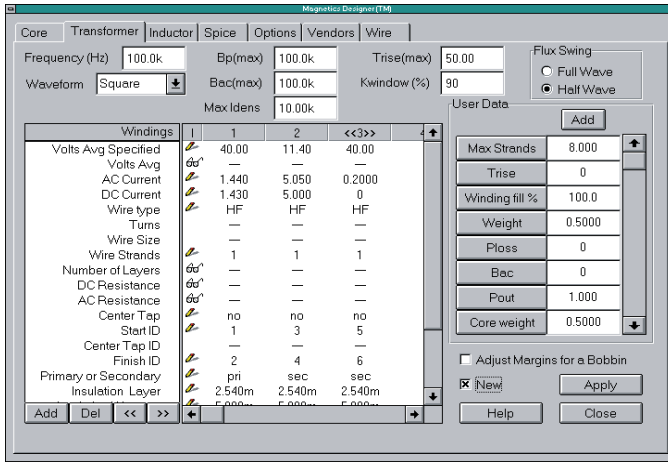

**Figure 4,** The Transformer design screen after entering the basic electrical requirements.

To start the initial calculation and optimization of the transformer design, we first check the New box (bottom right, Figure 4) and then select the Apply button. The History of Core Trials dialog, in Figure 5, displays the results of the optimization process. This includes the window fill and temperature rise for each core that has been tried in the selected family.

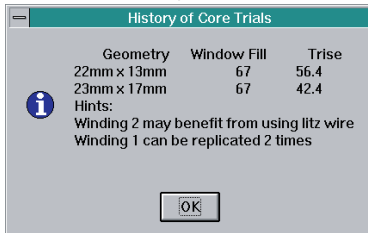

**Figure 5,** The History of Core Trials screen shows which cores were tried by Magnetics Designer.

The resulting transformer performance for the selected core (23mm x 17mm) is then displayed in the Transformer screen.

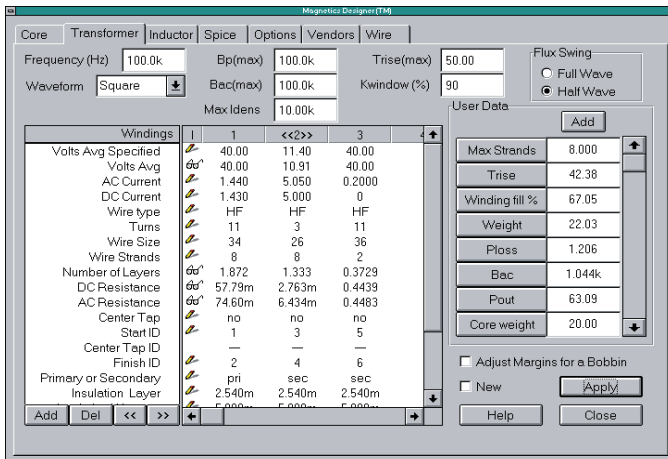

**Figure 6,** The Transformer screen and resulting design values after Magnetics Designer's optimization.

When the New option is selected, Magnetics Designer will iterate the design for successively larger cores until the temperature rise constraint is met or a new core can't be selected. For each core, Magnetics Designer will try to find the wire size, turns, and number of strands required to achieve the specified voltages, low AC/DC resistance, and optimal layer utilization, all while fulfilling the stated constraints of window fill and temperature rise.

As we have demonstrated in this case, the powerful algorithms in Magnetics Designer will normally produce a design that meets all stated requirements **without any further user input required!** Figure 6 shows that the layers are utilized quite well, and the Trise and Window fill values are approximately 42.38 degrees C and 67%, respectively.

While the initial design is satisfactory, it could be improved. The History of Core Trials dialog provides some recommendations on possibly improving the design. These may include changes to the wire type, number of parallel windings, and hints on smaller cores that may, with some adjustment, be able to handle the design parameters. For instance, Figure 5 shows that the smaller 22mm x 13mm core almost made the temperature rise. It may be a good candidate for further optimization.

Magnetics Designer may select a different core geometry, depending on the data changed in the Transformer screen. This geometry change may dramatically affect the overall transformer performance, and make it difficult to optimize a particular design. Therefore, it is best to "lock down" the core geometry (Figure 7).

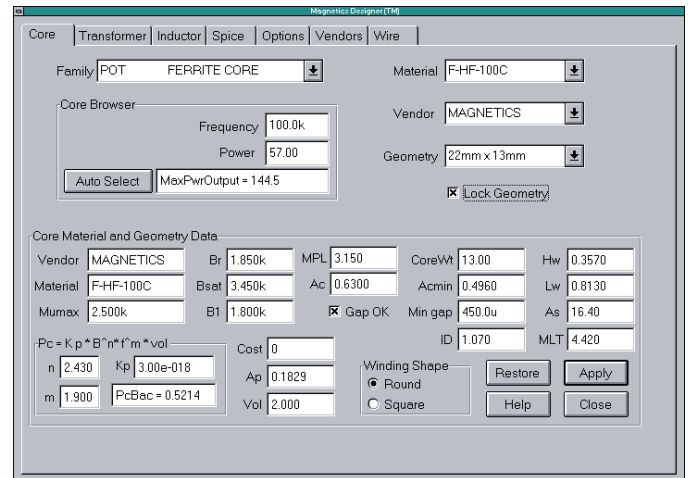

**Figure 7,** You can lock a particular core geometry in order to experiment with a different design improvements.

As shown in Figure 7, the 22mm x 13mm core is selected and the "Lock Geometry" option is checked. Since we have changed the core geometry, we must first check New and then select Apply so that Magnetics Designer can update the windings characteristics for the newly selected core. We find that the temperature rise is now 56.41 degrees, which is above our set constraint.

Let's try one of the previous suggestions and split winding 1 and 2 (once each) and then perform the New and Apply operations. Splitting the highest power winding can provide several benefits (i.e. better temperature rise for the same core area). The resulting transformer screen then looks like Figure 8.

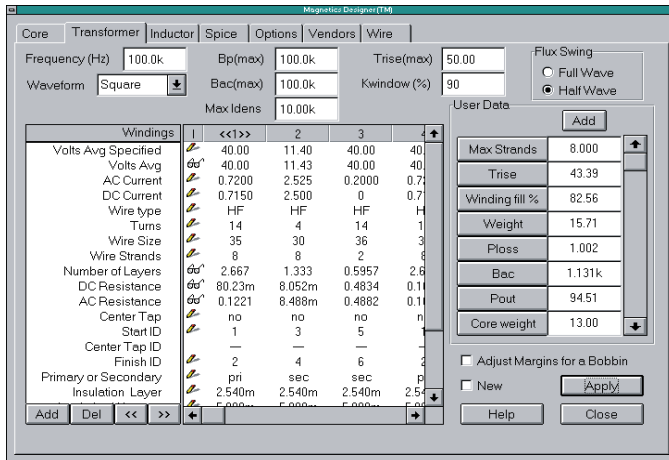

**Figure 8**, The transformer design after splitting the highest power winding.

Magnetics Designer knows that we are splitting a winding, rather than adding a new winding, and automatically splits the current between the two windings. **It should be noted that the AC resistance calculation includes both skin and proximity effects.** You can move the windings around and change the layer configuration by using the << and >> buttons at the bottom of transformer dialog. Magnetics Designer will recalculate the AC resistance based on the new configuration.

The simple operation of splitting the windings achieves the design goals for this smaller core. However, four of the windings now require 8 strands, which could be costly to manufacture.

We can set the maximum number of strands per winding via the Max Strands field. Located in the User data section of the Transformer screen, this series of buttons and fields provides access to both input variables and output results. Later in this article, we will explore how you can derive your own customized output results. In this case, we will change Max Strands from 8 to a more manageable 4. Magnetics Designer also allows you to change the type of wire for each windings. You have the choice of heavy formvar, small formvar, foil, square, double square, litz, or pcb traces (for planar magnetics).

Changes that affect the transformer geometrically should be accompanied by a recycling of the design using the New option. The Apply button alone (without New checked) is primarily used for minor design changes. With the New and Lock Geometry options checked, Magnetics Designer will "stir up" the windings using the selected geometry in order to arrive at the best set of characteristics.

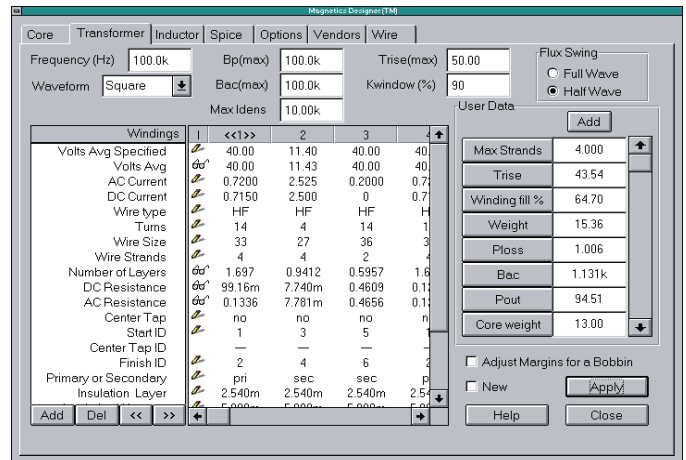

**Figure 8**, The transformer design after setting the maximum number of strands per winding to 4.

Figure 8 shows the resulting transformer screen which now meets all of the design goals again. The split winding information can be shown by scrolling the spreadsheet window. The ID numbers account for the paralleling of the various windings. By scrolling down the main spreadsheet window and the User Data button column on the right, we are able to see other calculated design data such as the efficiency, leakage inductance and parasitic capacitance (Figure 9).

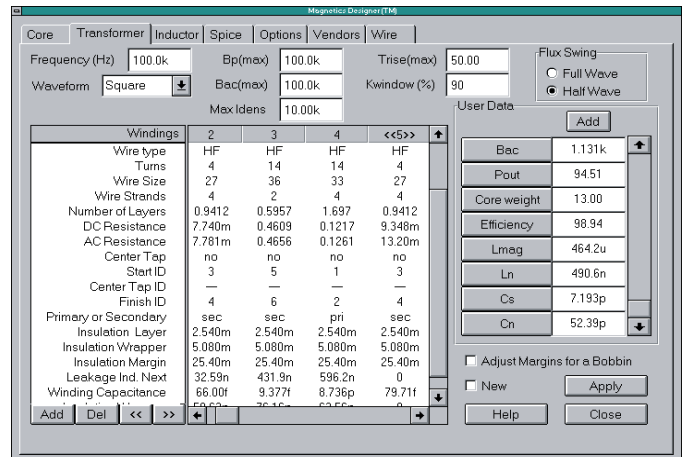
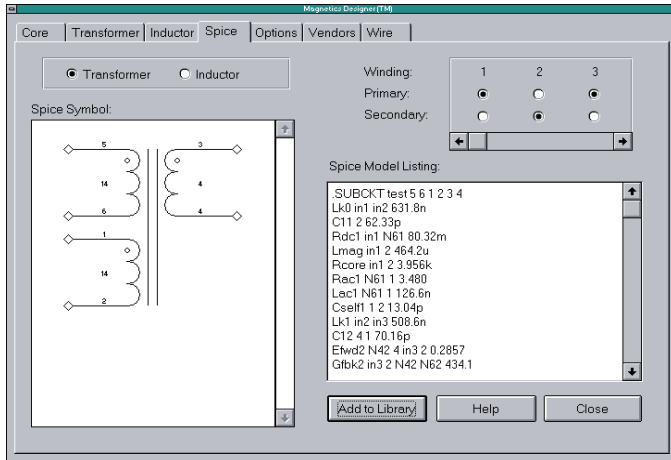

**Figure 9**, Magnetics Designer displays a wealth of calculated data in the spreadsheet (left) and User Data (right) areas.

### Magnetics Designer Has Unique Features

Magnetics Designer has two very unique features. The first is the ability to produce a **SPICE Model** of your transformer or inductor design. Figure 10 shows the SPICE screen which allows you to configure a schematic symbol and save the resulting SPICE 2 compatible subcircuit netlist. The model includes all the core and copper losses, AC/DC resistance, leakage and magnetizing inductance and winding capacitances. The leakage inductance is calculated based on a reluctance model while the capacitance values are based on a charge conserving representation.

SpiceNet, OrCAD, and Protel compatible schematic symbols are produced. This allows you to immediately use your new design in a schematic capture program and perform circuit simulations of your entire power system.



**Figure 10**, Magnetics Designer produces a SPICE model of your transformer or inductor design.

As an example of this capability, Figure 11 shows a SpiceNet schematic and IsSpice4 simulation results of a 50W forward converter using our transformer design.

IsSpice4 includes models for many PWM ICs, power semiconductors, and power electronics devices. When coupled with Magnetics Designer, the two make a complete circuit design and analysis system that no other software vendor can match.

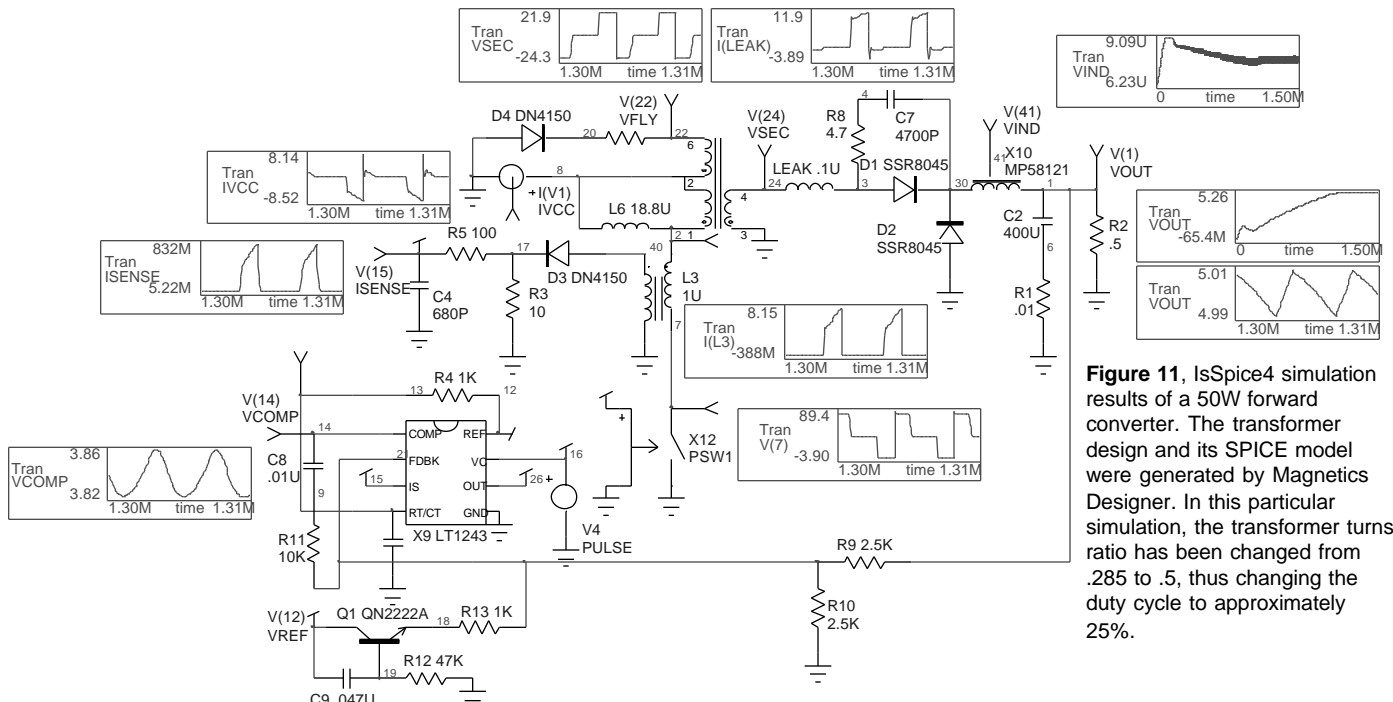

**Figure 11**, IsSpice4 simulation results of a 50W forward converter. The transformer design and its SPICE model were generated by Magnetics Designer. In this particular simulation, the transformer turns ratio has been changed from .285 to .5, thus changing the duty cycle to approximately 25%.

The second unique feature is the exposure of virtually all of the design variables used in the program. Magnetics Designer allows the user to freely create new output measurements and even affect the optimization criteria of the program. Parameters such as core area and flux density, thermal conductivity, power losses, leakage inductance and capacitive parasitics, resistance values, and mechanical specifications are all available.

Figure 12 shows an example of a new temperature variable which was created using the copper loss, core loss, core area, and ambient temperature parameters. Both user input and calculated output parameters are available, and additional equations may be added.

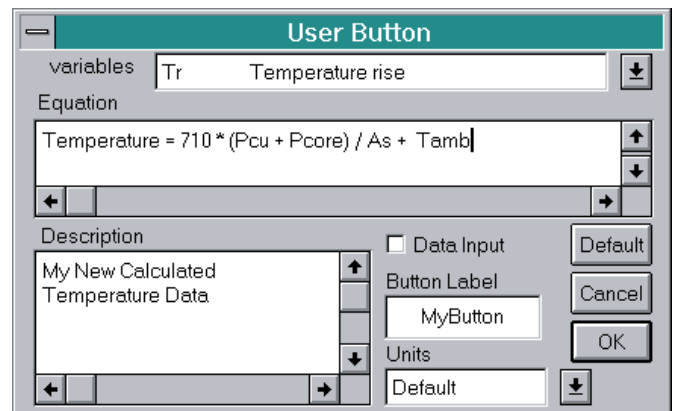

**Figure 12**, An example of a user generated equation that was added to the User Data area of the Transformer screen. The result of the equation will be shown in the User Data field next to the button.

This feature gives Magnetics Designer extreme flexibility and opens up many design boundaries for exploration.

**Magnetics Designer Reports**

Magnetics Designer produces a complete report of the characteristics of your design in the form of an electrical performance summary and a winding sheet. Output from a typical report will appear as follows:

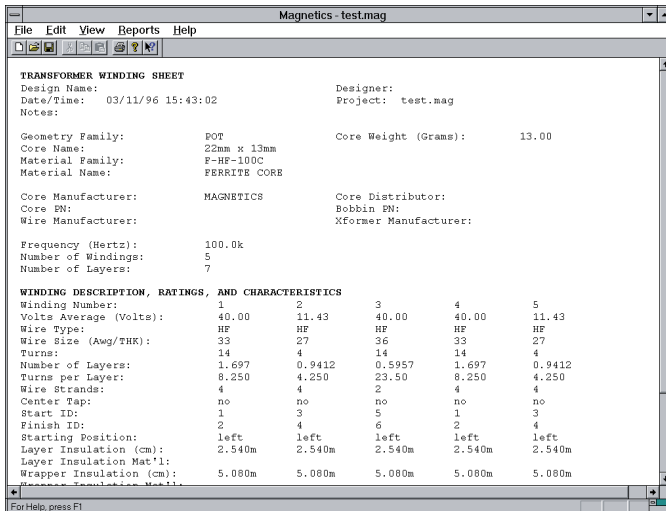

Figure 13, The Winding Sheet contains the manufacturing information for your transformer.

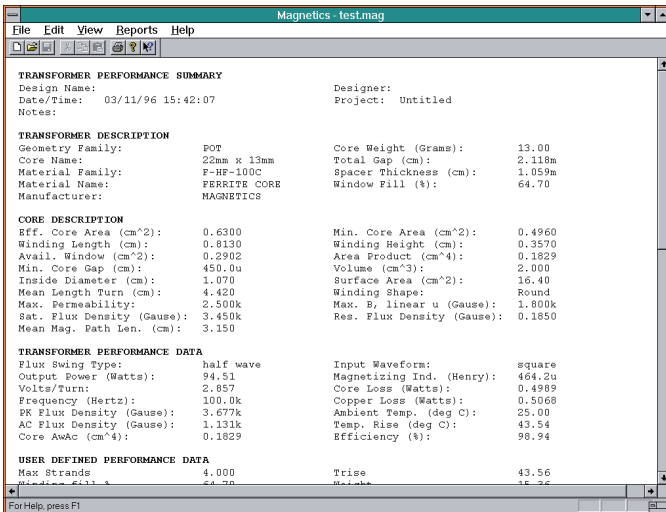

Figure 14, A summary of the electrical performance of your magnetic design includes all the information found in the core screen, transformer or inductor screens, and User Data fields.